

Höhenverstellung
 Regolazione in altezza
 Height adjustment
 Réglage de la hauteur
 Ajustable en altura
 Hoogte instelling

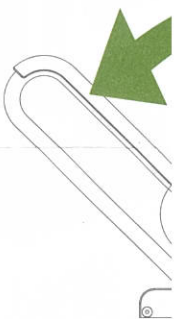

Rückenlehne
 Schienale
 Backrest
 Respaldo
 Dossier
 Rugleuning

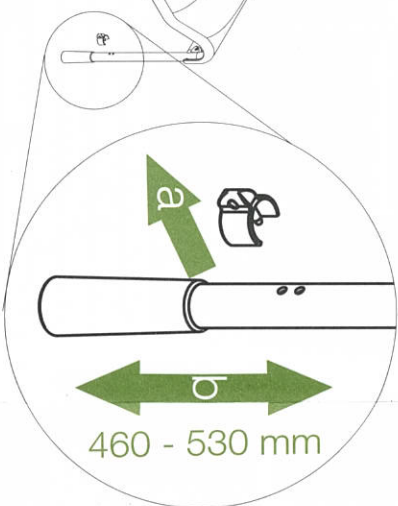
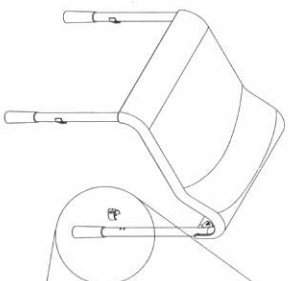
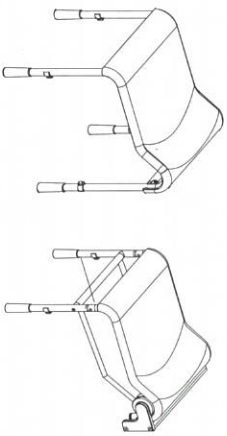
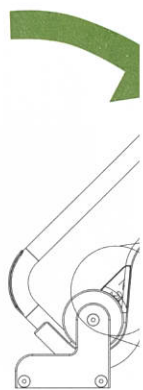
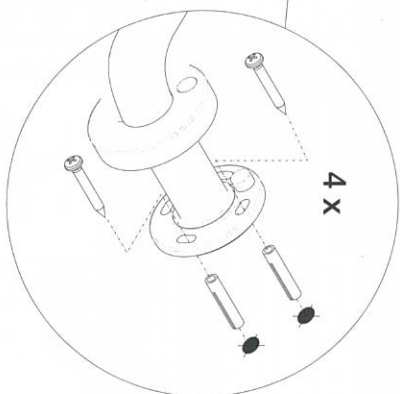
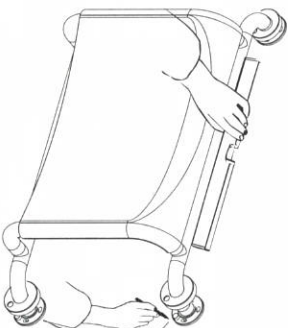
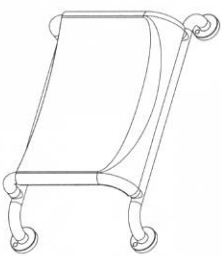

Griffmontage
 Montaggio braccioli
 Handle assembly
 Fixation de la poignée
 Montaje assidero
 Montage van de greep

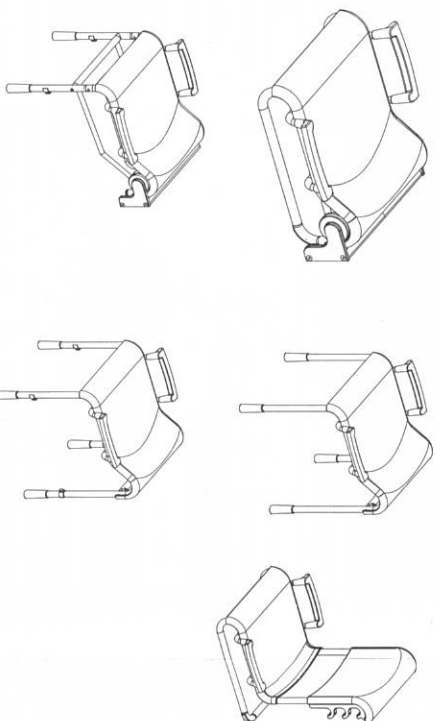

| | |
|-----|--|
| 2 x | |
| 8 x | |
| 8 x | |
| 1 x | |

